

new model
up to 40 GHz



Vector Network Analyzers ZVM, ZVK

Measurement systems meeting the highest standards – from 10 MHz to 20 GHz and 10 MHz to 40 GHz

- **Excellent dynamic range**
 - >115 dB (ZVM)
 - >110 dB (ZVK)
 - (measurement bandwidth 10 Hz)
- **Low inherent noise**
 - <-110 dBm
 - (measurement bandwidth 10 Hz)
- **High measurement speed**
 - <0.5 ms/point (ZVM)
 - <0.7 ms/point (ZVK)
- **Fast data transfer via IEC/IEEE bus**
 - Transfer time <15 ms (200 points)
- **Accurate calibration in test fixtures and on wafers**
 - Modern calibration techniques
 - TOM, TRM, TRL, TNA, TOM-X
- **Swept frequency-conversion and multitone measurements on amplifiers and mixers**
 - Arbitrary configuration of generator and receiver
 - Selective receiver with fundamental mixing
- **Easy integration into PC environment and networks**
 - Internal PC with Windows NT
- **Embedding of virtual matching networks**
 - Import of virtual networks using CAE-compatible file formats (*.S1P, *.S2P, *.S4P, *.flp)



ROHDE & SCHWARZ

Overview

Vector network analyzers of ZV family

The vector network analyzer family from Rohde&Schwarz comprises the units ZVRL, ZVRE, ZVCE, ZVR, ZVC, ZVM and ZVK. All units are equipped with generator, test set, reference and receiver channels. The analyzers differ in frequency range, unidirectional or bidirectional measurement capabilities, active or passive test set, number of reference channels and thus availability of calibration techniques.

For the units up to 4 GHz (ZVRL, ZVRE, ZVR) and 8 GHz (ZVCE, ZVC), a separate data sheet (PD757.1802) is available. In addition, a free-of-charge CD-ROM (Order No. 1007.9074.14-03) contains extensive information on the network analyzers – including manuals, application notes and startup information. Additional information can also be found on the Rohde & Schwarz web site (www.rohde-schwarz.com).

ZVK (active couplers)

10 MHz 40 GHz

ZVM (active couplers)

10 MHz 20 GHz

300 kHz 4 GHz

ZVR, ZVRE
(active bridges)

9 kHz 4 GHz

ZVR, ZVRE, ZVRL
(passive bridges)

10 Hz 4 GHz

ZVR, ZVRE, ZVRL
(with Ext. Measurements option)

20 kHz 8 GHz

ZVC, ZVCE
(active couplers,
passive bridges)

300 kHz 8 GHz

ZVC, ZVCE
(active bridges)

Network Analyzers ZVM and ZVK ...

Versatile test set for universal use

ZVM and ZVK are compact instruments with integrated generator, two reference and two receiver channels and a bidirectional test set. This can be extended by attenuators with integrated switches in the generator and receiver paths. With this configuration, ZVM and ZVK offer direct access to all reference and receiver channels. This concept makes ZVM and ZVK well equipped for complex test setups, for example for bidirectional measurements on power amplifiers.

Fundamental mixing concept

ZVM and ZVK have two independent synthesizers for the generator and the receiver. In the receiver sections, fundamental mixing is used up to high frequencies to provide the excellent dynamic range and outstanding selectivity, enabling straightforward measurements on frequency-converting DUTs or DUTs with extremely high selectivity.

Powerful and highly precise

Special calibration techniques

ZVM and ZVK feature modern calibration techniques patented by Rohde&Schwarz that allow full two-port calibration using fewer or only partially known standards. This simplifies the design of calibration standards used for example in test fixtures or on wafers. Thus calibration in non-coaxial systems can be performed with a minimum of effort at maximum accuracy and dynamic range.

Embedding and de-embedding of virtual networks, CAE software

The *Virtual Embedding Networks* option enables virtual embedding of arbitrary linear two-port networks into the test setup. The required data (*.S1P, *.S2P, *.S4P, *.flp) are obtained from a measurement of the existing network or generated by CAE tools from the theoretical model.

In tests of components that have to be matched to a given impedance, the matching network can thus be taken into account through mathematical algorithms of ZVM and ZVK instead of using the physical network. This method guarantees high accuracy, ideal reproducibility and maximum reliability without any loss of speed – great advantages especially in production.

Conversely, by de-embedding, the influence of a known network can be eliminated. The S-parameters of a chip can be analyzed, compensating for the effects of its housing and bonding leads through de-embedding.

Time-domain measurements

By transforming measurement data from the frequency to the time domain, discontinuities or impedances along the DUT can be displayed as a function of DUT length. With a maximum number of 2001 points, ZVM and ZVK can measure even very long DUTs with high resolution. Five filters allow the location of a discontinuity and the sidelobe suppression to be determined with optimum resolution. The S-parameters of a given discontinuity can be displayed in the time domain by setting a window (gating). An additional processor module included in the corresponding option accelerates data

... designed for the most stringent demands

processing and the display of results to provide even realtime display—a valuable aid, for example in the tuning of band-pass filters with time domain transformation.

Internal PC and Ethernet

ZVM and ZVK are based on Windows NT. The user has complete access to the hard disk, the floppy disk drive and all interfaces of the internal PC. This allows, for example, the connection of an external monitor, the installation of any type of

printer, or the use of software tools on ZVM or ZVK for result processing or control of the network analyzers via the IEC/IEEE bus or an internal RSIB*) data bus. ZVM and ZVK can thus act as controllers of their own or for a complete test or production system. Moreover, the internal PC enables control and data exchange via Ethernet.

Decoupled 4-channel display

In the decoupled mode, the frequency grid, measurement bandwidth, calibra-

tion technique and measurement mode can be configured independently for each of the four display channels. In amplifier measurements, this allows the simultaneous measurement and display of important parameters in quasi-realtime, such as gain, compression point (power

ZVM and ZVK extend the frequency range of the Rohde & Schwarz network analyzers to 20 GHz and 40 GHz. Their outstanding performance in terms of speed, dynamic range and accuracy shows already in standard applications such as S-parameter or group delay measurements. This is enhanced by a wealth of measurement, display and logging functions. In addition, ZVM and ZVK can be used for complex measurement tasks, for example measurements on frequency-converting DUTs (conversion loss, intermodulation, spurious) and nonlinear measurements (intercept point and compression point).

Highlights in brief

	ZVM	ZVK
Frequency range	10 MHz to 20 GHz	10 MHz to 40 GHz
Frequency resolution		100 μ Hz
Impedance		50 Ω
Test ports	PC 3.5 male	2.92 mm male
Measurement time (normalized)	<0.5 ms/point	<0.7 ms/point
Output power	+5 dBm/+2 dBm to -85 dBm	0 dBm/-5 dBm to -85 dBm
Power uncertainty		<1 dB to 2 dB
Dynamic range (IF bandwidth 10 Hz)	>85 dB (<0.5 GHz) >115 dB (0.5 GHz to 8 GHz) >110 dB (8 GHz to 16 GHz) >100 dB (16 GHz to 20 GHz)	>80 dB (<0.5 GHz) >110 dB (0.5 GHz to 8 GHz) >105 dB (8 GHz to 16 GHz) >90 dB (16 GHz to 20 GHz) >90 dB (20 GHz to 28 GHz) >80 dB (28 GHz to 40 GHz)
Measurement bandwidths		1 Hz to 10 kHz (in 9 steps) and 26 kHz
Calibration techniques	TOM, TRM, TNA, TOM-X, AutoKal (all Rohde & Schwarz patents), TRL, TOSM, normalization techniques	



sweep) and harmonics versus power or frequency, or compression point versus frequency (see screen display below).

Time-optimized calibration, measurement and control

The Rohde&Schwarz two-port calibration techniques reduce the number of required

calibration standards to a minimum of 2. This significantly cuts the time required for manual calibration. The short measurement time of <500 μs or <700 μs per point guarantees minimum sweep times through to realtime display. The output of a marker value via the IEC/IEEE bus takes

less than 5 ms, the transfer of a complete trace (200 points) less than 15 ms. These features are the basis for the excellent performance of ZVM and ZVK both in manual operation and in automated test systems.

*) Remote control via an internal software interface using the same SCPI command syntax as for normal

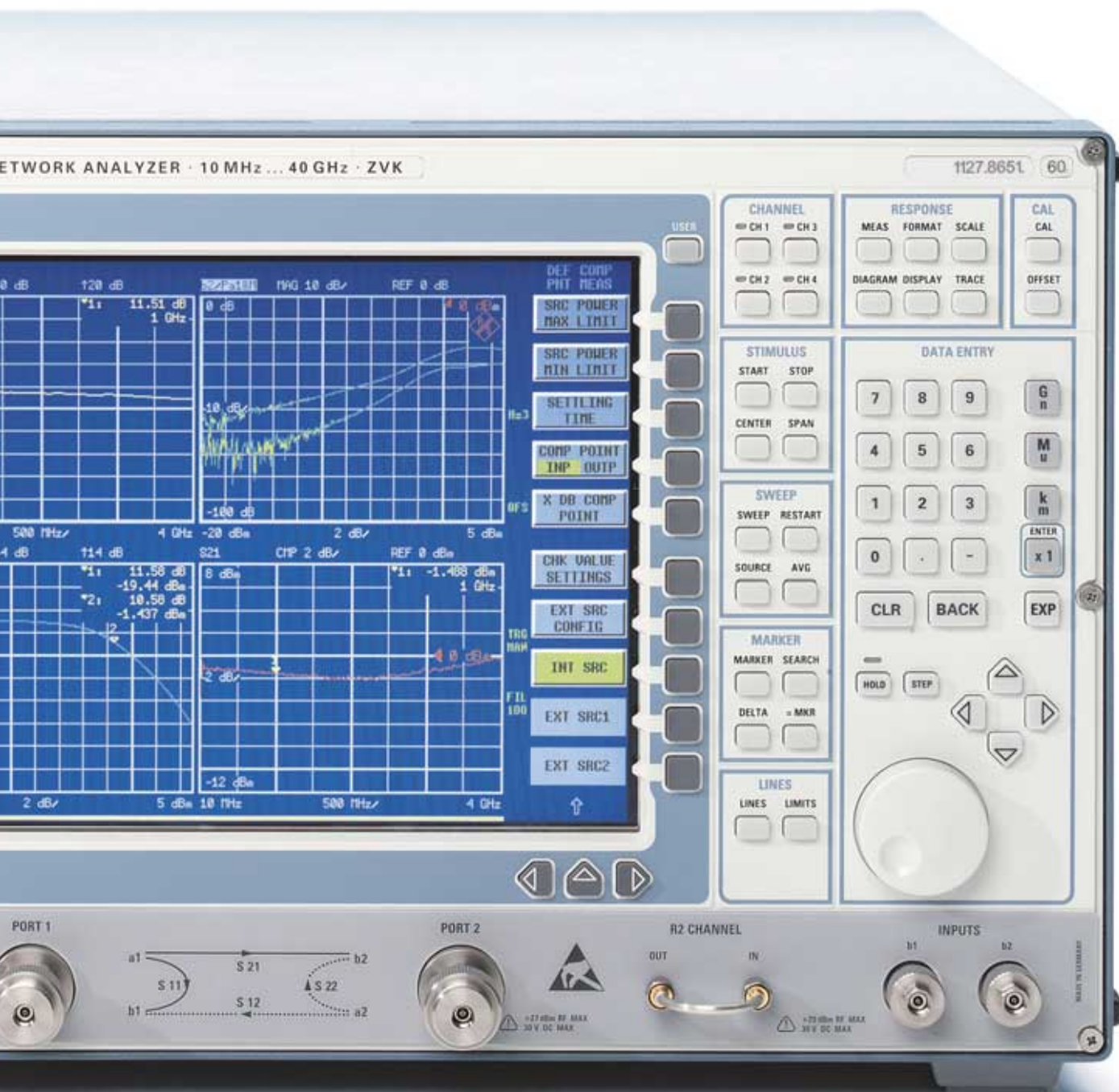

Convincing concepts – features in detail

1



The Rohde & Schwarz calibration techniques offer maximum convenience and accuracy also for on-wafer measurements

Extremely short measurement times

A powerful microprocessor system combined with ultra-fast synthesizers makes for extremely short measurement times even with a large number of test points and small measurement bandwidths (Fig. 3). This in conjunction with short IEC/IEEE-bus access and transfer times considerably speeds up automated test and production sequences.

Ultra-wide dynamic range

The extremely low-noise front end, using fundamental mixing, yields a dynamic range that, with appropriate configuration, by far exceeds the specified values of 115 dB (Fig. 2) and 110 dB. This exceptionally wide range makes it possible to measure RF components with high stop-band attenuation and achieve high accuracy also at low power levels.

Patented calibration techniques

Besides various normalization techniques, ZVM and ZVK offer the classic 12-term TOSM technique (**T**hrough, **O**pen, **S**hort, **M**atch). In addition, the analyzers feature as standard other calibration techniques mostly patented by Rohde & Schwarz: **TOM**, **TRM**, **TRL**, **TNA**, **TOM-X** (Fig. 4).

The standards are defined as follows *):

THROUGH

Through-connection of known length

OPEN

Open circuit of known length and phase response

SHORT

Short circuit of known length

MATCH

Matched termination

Bandpass filter measurement with ZVM: the extremely low-noise front end based on fundamental mixing yields a dynamic range of up to >140 dB (not guaranteed)

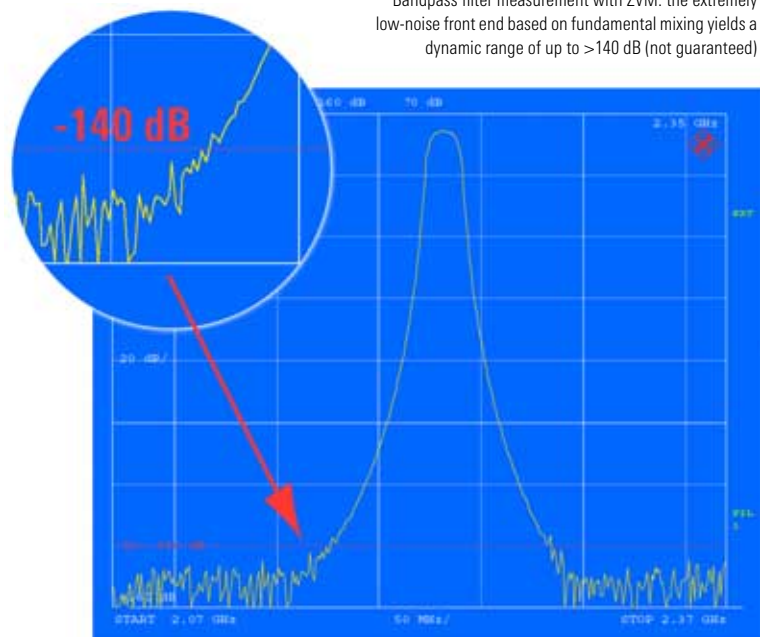

2

*) For detailed description see specifications.

LINE
Ideal matched line of known length

REFLECT
Reflecting one-port standard, identical for PORT 1 and PORT 2

NETWORK
Symmetrically reflecting two-port standard

ATTENUATOR
Matched attenuator with unknown attenuation

The advantage of the 7-term calibration techniques (TRL, TNA, TRM, TOM) is the reduced number of calibration standards required and their simplified description. In particular, the use of REFLECT or NETWORK avoids the use of OPEN and thus the complex determination of the fringing capacitance. This allows the design and production of calibration standards at reasonable cost and enables

accurate, full two-port calibration in test fixtures or on wafers (Fig. 1).

TRL is recommended where high directivity is necessary.

TNA is recommended for applications with symmetrical test ports and where a well-matched two-port or double match (ATTENUATOR) can be provided in sufficient quality. If the calibration step is carried out with NETWORK, the test fixture can simply be left open. Thus a full two-port calibration can be performed with only two standards and the same accuracy as TOSM.

TOM offers the advantage of implicit verification: errors resulting from faulty calibration standards or operator errors are automatically detected with high probability and thus avoided already during calibration.

Measurements on amplifiers and frequency-converting DUTs

The system concept of ZVM and ZVK with two independent synthesizers for the generator and receiver sections enables versatile measurements with excellent accuracy, wide dynamic range and high measurement speed on frequency-converting and nonlinear DUTs such as amplifiers and mixers. Three generators (one internal, two external) can be configured and controlled independently of each other. The fundamental mixing concept of ZVM and ZVK and the resulting high selectivity make additional external filters superfluous. The receiver will even detect weak signals such as intermodulation products and spurious, since the full sensitivity and dynamic range of ZVM and ZVK are available also for selective, frequency-converting DUTs.

3

Measurement times			
Frequency sweeps with 401 test points			
	IF bandwidth 10 kHz		
	ZVM	ZVK	
Frequency range 10 MHz to 20 GHz or 10 MHz to 40 GHz Two-port calibrated, bidirectional Normalized, unidirectional	340 ms 210 ms	430 ms 260 ms	
Frequency range 1 GHz to 2 GHz Two-port calibrated, bidirectional Normalized, unidirectional	260 ms 140 ms	290 ms 130 ms	
IEC/IEEE-bus data transfer times for real and imaginary parts			
Time between sending of query and availability of data			
Number of test points	51	201	401
ASCII	40 ms	90 ms	160 ms
IEEE-754 floating point format (setting data 64 bit, measurement data 32 bit)	10 ms	15 ms	25 ms

Left: measurement and IEC/IEEE-bus times of ZVM and ZVK

Below: comparison of two-port calibration techniques

Two-port calibration techniques	Number of calibration steps	Special feature
TOM	5	Implicit verification
TRM	5	Especially for test fixtures
TRL	4	High directivity
TNA	3	Especially for planar circuits
TOSM	7	Classical method
TOM-X	5 (9)	Eliminates crosstalk

4

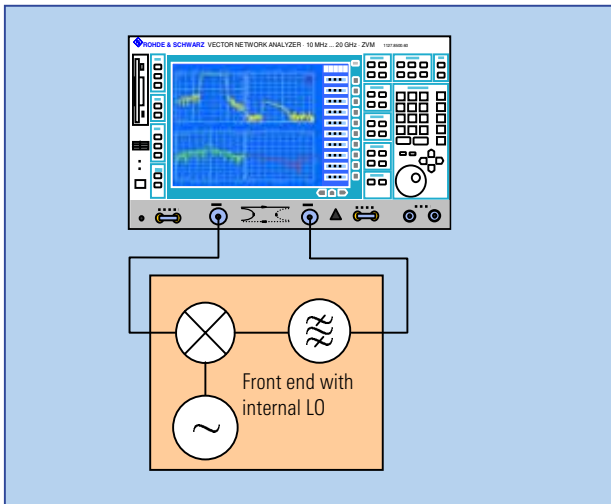

Test setup for front-end measurement

The features in detail (cont'd)

Frequency-converting and nonlinear DUTs of any type (e.g. front ends, see Fig. 5) can thus be measured with little effort. The decoupled measurement and display mode permits the simultaneous display of different parameters on ZVM or ZVK (Figs 6 and 7).

The user-friendly MIXER MODE menu makes it very easy to configure mixer measurements with constant or swept RF, IF or LO. For more complex measurement tasks, the ARBITRARY mode offers almost unlimited configurations of the internal and the external generators and the receiver of ZVM and ZVK.

Typical measurements on amplifiers, frequency converters, multipliers, dividers, synthesizers etc are:

- sidebands of mixers with fixed or tracking IF
- any harmonics versus frequency or power
- intermodulation products of amplifiers and mixers (e.g. IP3, IP5, IP7...)
- spurious

Amplifier measurement: simultaneous display of gain, compression and harmonics versus power, and display of compression point versus frequency

- mixture products of DUTs with multiple frequency conversion, multipliers, dividers and combinations of such components

In amplifier measurements, ZVM and ZVK can display even nonlinear parameters versus frequency, e.g.:

- n dB compression point
- second-order intercept point (SOI)
- third-order intercept point (TOI)

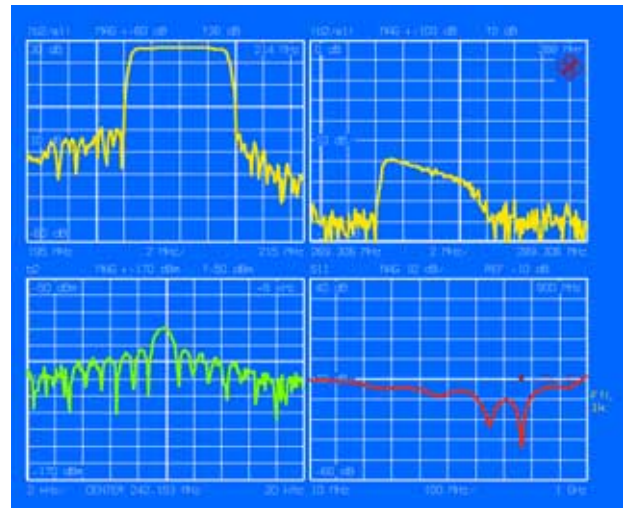

Front-end measurement: simultaneous display of both sidebands, LO crosstalk and RF input matching

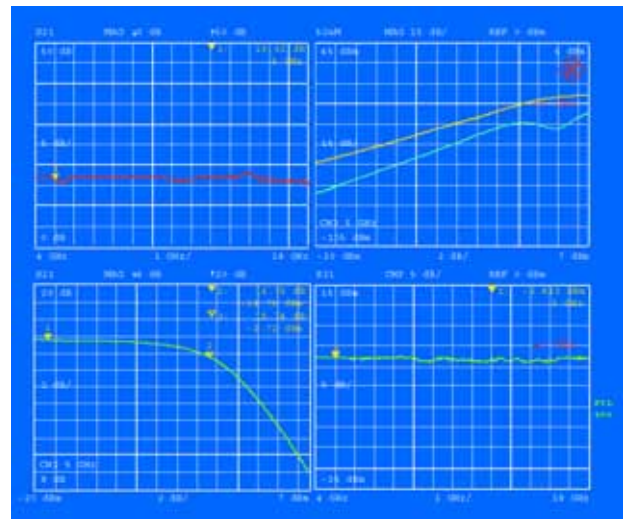

The Rohde&Schwarz network analyzers offer system error and power correction, yielding high accuracy in the measurement of S-parameters and absolute power.

Two DC inputs at the rear enable the display of DC voltages versus frequency, and in amplifier measurements the power added efficiency (PAE) can be displayed.

Test set and system configuration

ZVM and ZVK are four-channel instruments with two measurement and two reference channels. The test sets are of fully symmetrical design in the forward and the reverse direction (Fig. 8).

During a bidirectional sweep, the electronic RF switch applies the signal to the DUT at every frequency point in the forward and the reverse direction: ZVM and ZVK thus indicate the fully corrected measured values during the sweep – a valuable aid in alignments at small measurement bandwidths.

Optional step attenuators (ZVM-B21 to -B24, ZVK-B21 to -B24) with attenuation from 0 dB to 70 dB in steps of 10 dB can be inserted into the generator and receiver paths (Fig. 8).

The attenuators extend the output power range down to -90 dBm and the maximum input power at PORT 1/2 to $+27$ dBm.

If ZVM or ZVK are fitted with an attenuator in a receiver path, an additional test port – INPUT b1 or INPUT b2 – is available on the front panel. An internal switch in the attenuator enables direct access to the respective receiver channel, bypassing the coupler. Sensitivity and dynamic range are thus increased by typically 10 dB. The two reference channels can be accessed directly too, since the associated paths are routed via the front panel as standard (R1 CHANNEL IN/OUT, R2 CHANNEL IN/OUT, Fig. 8). In the case of ZVM, the PORT 1, PORT 2, INPUT b1 and INPUT b2 test ports are PC3.5 male connectors, the inputs and outputs of the reference channels are SMA female connectors. In the case of ZVK, all ports are 2.92 mm male connectors, the inputs and outputs of the reference channels are 2.92 mm female connectors.

A network analyzer equipped with receiver step attenuators not only offers sensitivity and dynamic range increased by 10 dB, but also the functionality of an instrument without a test set ("Delete Testset"), i.e. direct access to the reference and measurement channels.

Active DUTs can be powered and driven via the inner conductors of PORT 1 and PORT 2 with DC voltage of up to 30 V or 200 mA. The required DC power is applied via rear-panel BNC connectors.

The flexible concept of the network analyzers allows the configuration of complex external test sets for special measurement tasks such as:

- group delay of mixers with the aid of a reference mixer
- high-power measurements on power amplifiers using a test set with preamplifiers (Fig. 9)
- S_{22} measurement on power amplifier during operation

Test set of ZVM and ZVK

Proposal of external test set for measurements on power amplifiers (DUTs)

8

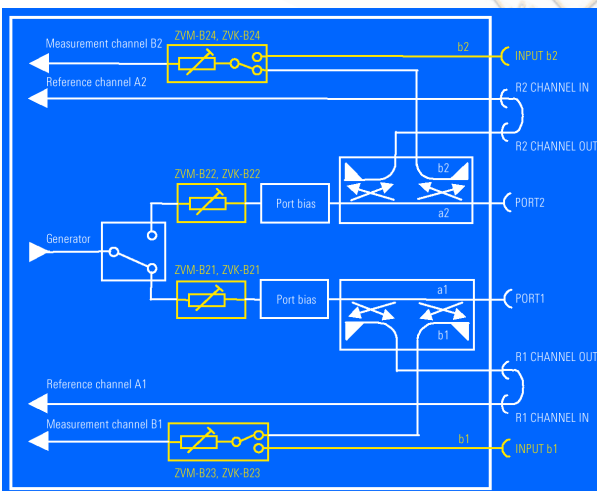

9

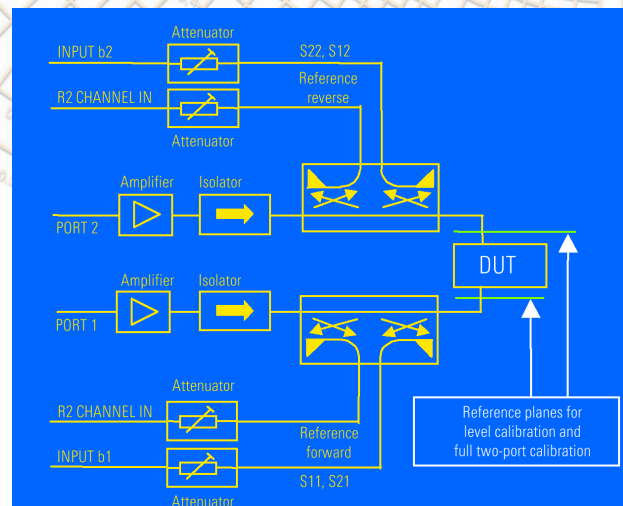

Specifications

Unless otherwise stated, specifications apply to test ports **PORT 1** and **PORT 2**, a nominal output power of **-10 dBm** at the source port and an **IF bandwidth ≤10 kHz**.

Especially important data are framed in blue

Measurement range

Characteristic impedance	50 Ω
---------------------------------	------

Port connectors

ZVM	3.5 mm (male)
ZVK	2.92 mm (male)

Frequency

Range ZVM	10 MHz to 20 GHz
Range ZVK	10 MHz to 40 GHz
Uncertainty	$4 \times 10^{-6} + 1 \times 10^{-6} \times$ operating time in years
Resolution	100 μHz

Number of test points (selectable) 1 to 2001

Measurement time

per point with min. 400 points and IF bandwidth of		ZVM	ZVK
	10 Hz	10 kHz	10 kHz
with system error correction	<200 ms	<0.9 ms	<1.1 ms
normalized	<100 ms	<0.5 ms	<0.7 ms

Dynamic range

(without system error correction, without optional attenuator) at IF bandwidth of	ZVM	ZVM	ZVK	ZVK
up to 500 MHz	>75 dB	>45 dB	>70 dB	>40 dB
500 MHz to 8 GHz	>115 dB	>85 dB	>110 dB	>80 dB
8 GHz to 16 GHz	>110 dB	>80 dB	>105 dB	>75 dB
16 GHz to 20 GHz	>100 dB	>70 dB	>90 dB	>60 dB
20 GHz to 28 GHz			>90 dB	>60 dB
28 GHz to 40 GHz			>80 dB	>50 dB

(The dynamic range is defined as the difference between the maximum nominal source power and the peak value displayed after smoothing the measured trace for the transmission magnitude with an aperture of 1%, the trace being caused by inherent noise and crosstalk, with test ports short-circuited.)

Measurement bandwidths

(IF bandwidths)	1 Hz to 10 kHz (half-decade steps) and 26 kHz (full)
-----------------	--

Measurement accuracy

The following data are valid between 20°C and 26°C, provided the instrument has reached thermal equilibrium (about 1 h after switch-on) and the temperature has not varied by more than 1 K after calibration. Validity of the data is conditional on the use of a suitable calibration kit by which the effective system data specified below are achieved.

ZVM uncertainty of transmission measurements

after system error correction

Specifications are based on a matched DUT, an IF bandwidth of 10 Hz, and a nominal output power of -10 dBm at the source port.

10 MHz to 500 MHz	
for +15 dB to -25 dB	0.2 dB or 2°
for -25 dB to -35 dB	1 dB or 6°
500 MHz to 8 GHz	
for +15 dB to +5 dB	0.2 dB or 2°
for +5 dB to -50 dB	0.1 dB or 1°
for -50 dB to -65 dB	0.2 dB or 2°
for -65 dB to -80 dB	1 dB or 6°

8 GHz to 16 GHz	
for +15 dB to -55 dB	0.2 dB or 2°
for -55 dB to -70 dB	1 dB or 6°
16 GHz to 20 GHz	
for +12 dB to +5 dB	0.3 dB or 3°
for +5 dB to -30 dB	0.2 dB or 2°
for -30 dB to -45 dB	0.3 dB or 3°
for -45 dB to -60 dB	1 dB or 6°

ZVM uncertainty of reflection measurements

after system error correction

Specifications are based on an isolating DUT, an IF bandwidth of 10 Hz, and a nominal output power of -10 dBm at the source port.

10 MHz to 20 GHz	
for +10 dB to +3 dB	0.6 dB or 4°
for +3 dB to -15 dB	0.4 dB or 3°
for -15 dB to -25 dB	1 dB or 6°
for -25 dB to -35 dB	3 dB or 20°

Variation of data trace

at 0 dB per Kelvin of temperature variation <0.2 dB or <2°

ZVK uncertainty of transmission measurements

after system error correction

Specifications are based on a matched DUT, an IF bandwidth of 10 Hz, and a nominal output power of -10 dBm at the source port.

10 MHz to 500 MHz	
for +10 dB to -15 dB	0.2 dB or 2°
for -15 dB to -30 dB	1 dB or 6°
500 MHz to 8 GHz	
for +10 dB to +5 dB	0.2 dB or 2°
for +5 dB to -45 dB	0.1 dB or 1°
for -45 dB to -60 dB	0.2 dB or 2°
for -60 dB to -75 dB	1 dB or 6°
8 GHz to 16 GHz	
for +10 dB to -50 dB	0.2 dB or 2°
for -50 dB to -65 dB	1 dB or 6°
16 GHz to 28 GHz	
for +5 dB to -20 dB	0.2 dB or 2°
for -20 dB to -35 dB	0.3 dB or 3°
for -35 dB to -50 dB	1 dB or 6°
28 GHz to 40 GHz	
for +5 dB to -10 dB	0.2 dB or 2°
for -10 dB to -25 dB	0.3 dB or 3°
for -25 dB to -40 dB	1 dB or 6°

ZVK uncertainty of reflection measurements

after system error correction

Specifications are based on an isolating DUT, an IF bandwidth of 10 Hz, and a nominal output power of -10 dBm at the source port.

10 MHz to 20 GHz	
for +5 dB to -15 dB	1 dB or 6°
for -15 dB to -30 dB	3 dB or 20°
20 GHz to 40 GHz	
for +5 dB to 0 dB	2 dB or 15°
for 0 dB to -10 dB	1 dB or 6°
for -10 dB to -25 dB	3 dB or 20°

Variation of data trace

at 0 dB per Kelvin of temperature variation <0.2 dB or <2°

Effective system data

The following data are valid between 20°C and 26°C, provided the instrument has reached thermal equilibrium (about 1 h after switch-on) and the temperature has not varied by more than 1 K after calibration. The data are based on an IF bandwidth of 10 Hz and system error calibration by means of a suitable calibration kit.

Frequency range	50 MHz to 20 GHz		above 20 GHz
	ZVM	ZVK	ZVK
Directivity	>46 dB	>42 dB	>38 dB
Source match	>36 dB	>36 dB	>33 dB
Reflection tracking	<0.1 dB	<0.1 dB	<0.1 dB
Load match	>46 dB	>42 dB	>38 dB
Transmission tracking	<0.1 dB	<0.1 dB	<0.2 dB

Output power

Range without optional generator step attenuator		
	ZVM	ZVK
up to 16 GHz	-20 dBm to +5 dBm	-20 dBm to 0 dBm
above 16 GHz	-20 dBm to +2 dBm	-20 dBm to -5 dBm
Uncertainty at -10 dBm		
without optional power calibration	2 dB	2 dB
150 MHz to 16 GHz in temperature range 20°C to 26°C	1 dB	1 dB
Linearity (referred to -10 dBm)		
above 150 MHz in temperature range 20°C to 26°C	<1 dB	<1 dB
Resolution		
	0.1 dB	0.1 dB

Spectral purity

Harmonics		
at maximum nominal source power		
	ZVM	ZVK
up to 10 GHz	<-23 dBc	<-20 dBc
10 GHz to 20 GHz	<-17 dBc	<-15 dBc
above 20 GHz		<-25 dBc
at -10 dBm source power		
up to 10 GHz	<-30 dBc	<-30 dBc
above 10 GHz	<-25 dBc	<-25 dBc
Spurious		
	<-35 dBc	<-35 dBc

SSB phase noise

1 Hz bandwidth, 10 kHz from carrier	
up to 150 MHz	<-100 dBc
150 MHz to 1 GHz	<-90 dBc
above 1 GHz	<-90 dBc + 20 x log (f/GHz)
	<-78 dBc at 4 GHz
	<-72 dBc at 8 GHz
	<-64 dBc at 20 GHz
	<-58 dBc at 40 GHz (ZVK)

Residual FM

RMS weighting from 10 Hz to 3 kHz	
up to 150 MHz	<2 Hz
150 MHz to 1 GHz	<5 Hz
1 GHz to 2 GHz	<10 Hz
2 GHz to 4 GHz	<20 Hz
4 GHz to 8 GHz	<40 Hz
8 GHz to 20 GHz	<80 Hz
20 GHz to 40 GHz (ZVK)	<160 Hz

Input level

Maximum nominal input level

without optional receiver step attenuator	+5 dBm
with receiver step attenuator set to 0 dB	+5 dBm
with receiver step attenuator set to ≥30 dB	+27 dBm

Level measurement uncertainty (without optional power calibration)

in temperature range 20 °C to 26 °C		
up to 500 MHz	for +5 dBm to -45 dBm	2 dB
500 MHz to 16 GHz	for +5 dBm to -70 dBm	2 dB
16 GHz to 20 GHz	for +5 dBm to -50 dBm	2 dB
20 GHz to 28 GHz	for +5 dBm to -50 dBm (ZVK)	3 dB
above 28 GHz	for +5 dBm to -30 dBm (ZVK)	4 dB

Damage level

without optional receiver step attenuator	+27 dBm
with receiver step attenuator set to 0 dB	+27 dBm
with receiver step attenuator set to ≥30 dB	+30 dBm

Damage DC current/voltage

0.5 A or 30 V

RMS noise level at IF bandwidth 10 Hz

up to 500 MHz	<-80 dBm
500 MHz to 8 GHz	<-110 dBm
8 GHz to 16 GHz	<-105 dBm
16 GHz to 20 GHz	<-95 dBm
20 GHz to 28 GHz (ZVK)	<-95 dBm
above 28 GHz (ZVK)	<-85 dBm

Match (without system error correction)

up to 50 MHz	>10 dB
50 MHz to 8 GHz	>12 dB
8 GHz to 20 GHz	>10 dB
above 20 GHz (ZVK)	>8 dB

Reference channel inputs

R CHANNEL IN

	ZVM	ZVK
Connectors	SMA (female)	2.92 mm (female)
Match	>12 dB	>8 dB
Maximum nominal input level	+5 dBm	+5 dBm
Damage level	+20 dBm	+20 dBm

System error correction techniques

ZVM and ZVK offer normalizations for reflection and transmission measurements, full one-port calibration (3-term, OSM), one-path two-port calibration, and the classic 12-term two-port calibration (TOSM). In addition, the following full two-port calibration methods are available: **TOM**, **TRM**, **TRL**, **TNA** and **TOM-X** (15-term). TOM, TRM, TNA and TOM-X are calibration methods patented by Rohde&Schwarz.

The names of the methods indicate the standards used for calibration:

T = Through

The T standard is a two-port standard which establishes a direct low-loss connection between the two test ports. A frequency-dependent attenuation can be taken into account by the analyzer. The standard has to be well-matched and may have any electrical length, which has to be exactly known (compare L standard).

O = Open

The O standard is a one-port standard. It realizes total reflection with a magnitude of 1 in the ideal case and a phase of approx. 0°. The phase response versus frequency must be accurately known to the analyzer (coefficients C_n). A frequency-dependent increase of the return loss can be taken into account by the analyzer. The electrical length of the O standard may differ from zero and must be exactly known.

S = Short

The S standard is a one-port standard. It realizes total reflection with a magnitude of 1 in the ideal case and a phase of approx. 180° at short-circuit plane (coefficients L_j). A frequency-dependent increase of the return loss can be taken into account by the analyzer. The electrical length of the S standard may differ from zero and must be known. It causes a length-proportional frequency dependence of the phase.

M = Match

The M standard is a one-port standard which in the ideal case realizes a zero-reflection termination for the reference impedance (mostly 50 Ω). A sliding match is often used at high frequencies because it yields higher effective directivities than fixed loads.

R = Reflect

The R standard is a one-port standard. In contrast to the M standard it features high reflection which may assume any unknown value. It must be known however whether the reflect approaches an open or a short circuit. If line transformation is to be expected from open to short because of the electrical length of the R standard, the electrical length has to be approximately known.

L = Line

The L standard is a two-port standard. It establishes an almost perfectly matched connection between the two test ports and defines the reference impedance. A frequency-dependent attenuation caused by the L standard can be taken into account by the analyzer. The L standard has to have an electrical length different from that of the T standard, but the difference should not amount to an integer multiple of half the wavelength (singularity).

N = Network

The N standard is a two-port standard featuring symmetrical reflection which may assume any value other than zero but has to be identical at both ports. Same as with the R standard it must be known whether the reflection approaches an open or a short circuit. Transmission of the N standard is arbitrary, need not be known and may vary arbitrarily versus frequency. In the extreme case it may even be 1 or zero.

A = Attenuator

The A standard is a two-port standard. It has to be well-matched and may feature any unknown attenuation different from that of the T standard.

TOM-X (X = crosstalk) is an extension of the TOM method. It considers all possible crosstalk between the four receiver channels (full model). Since this technique does not use approximations, it is particularly effective in the elimination of crosstalk and thus in increasing the effective dynamic range of the system. This method however needs a higher effort.

Display

Screen	26 cm colour LCD
Resolution	640 x 480 x 256
Sweep modes	frequency, power, and time
Parameter formats (examples)	S parameters and derived quantities like SWR, impedance, admittance, group delay, etc, as well as nonlinear parameters (optional) like n dB compression point, SOI and TOI. Complex parameters are displayed either in a complex form or formatted to magnitude, phase, real or imaginary part
Diagrams (examples)	Cartesian: linear, simple or double logarithmic, segmented polar: linear, logarithmic or segmented, Smith (any zoom), inverted Smith, Charter
Scaling (examples)	0.001 dB/ to 50 dB/ 1 m°/ to 200 k°/ 1 pU/ to 1 GU/ (automatically variable number of grid lines through MAX/MIN scaling)
Multichannel display	up to 4 independent display channels (CH1 to CH4)

Screen formats (examples)	overlay, dual channel split, quad channel split
Markers	8 normal markers or 7 delta markers for each display channel
Marker resolution	4 significant digits
Marker formatting	selectable, independent of trace formatting
Automatic marker functions	marker tracking, marker search, marker target, band filter functions (Q, shape factor, etc)
Trace mathematics	all four arithmetical operations with up to three operands
Display lines	horizontal lines, circles or radial lines
Limit lines	pairs of curves formed from line segments in Cartesian diagrams, any circles in polar diagrams

Further connectors (rear panel)

PORT BIAS 1/2

(DC bias inputs for PORT 1/2)

Max. nominal input current/voltage	200 mA/30 V
Damage current/voltage	500 mA/30 V

EXT TRIGGER (input for external trigger signal)

Edge-triggered TTL signal, polarity (selectable)	positive or negative
Minimum pulse width	1 μs

LEVEL (input for external level control)

Frequency range	0 Hz to 100 kHz
Voltage range	0 V to 10 V
Input impedance	>10 kΩ

DC MEAS INPUTS DC 1/2 (DC measurement inputs)

Voltage range	-10 V to +10 V
Measurement uncertainty	0.1 V
Input impedance	>10 kΩ

EXT FREQ REF IN (input for external reference frequency)

Frequency (in 1 MHz steps)	1 MHz to 15 MHz
Max. permissible deviation	6×10^{-6}
Input level (V_{rms})	0.1 V to 3 V
Input impedance	1 kΩ

EXT FREQ REF OUT (output of internal reference frequency)

Frequency	10 MHz
Frequency uncertainty	$4 \times 10^{-6} + 1 \times 10^{-6} \times$ operating time in years
Level (sine)	12 dBm ± 3 dB into 50 Ω

EXTERNAL GENERATOR

Connectors for high-speed control of an external generator from Rohde & Schwarz families SME, SMP, SMT, etc. The BLANK signal is low at each frequency point of the sweep and high during the transition from one point to the next. The network analyzer controls the external generator by means of the TRIGGER signal. To set the generator to the next frequency point, the TRIGGER signal goes high for a brief period.

BLANK (input) TTL signal

TRIGGER (output) TTL signal

ANALYZER MONITOR IBM-PC-compatible VGA connector for analyzer screen

PC MONITOR IBM-PC-compatible VGA connector for PC screen

MOUSE IBM-PC-compatible PS/2 connector

KEYBOARD IBM-PC-compatible 5-contact DIN connector

USER (input/output) 16 bit TTL, user-programmable, 25-contact sub-D

COM 1/ COM 2	IBM-PC-compatible serial interfaces, RS232, 9-contact sub-D
IEC BUS	remote-control interface IEEE488, IEC625, 24-contact (for general applications)
IEC SYSTEM BUS	remote-control interface IEEE488, IEC625, 24-contact (for control of generators, eg as local oscillators in mixer measurements)
LPT	IBM-PC-compatible printer interface, Centronics, 25-contact sub-D
MULTIPOINT	control of optional three-port and four-port adapters

Optional interfaces (eg LAN Ethernet) are available and specified separately.

Options

Time Domain option

Display and gating of measured values in the time domain and transformation back to the frequency domain.

Mixer Measurements option

This option allows network analysis for frequency-converting DUTs (single and multiple conversion) and almost any kind of harmonics and spurious measurements to be performed.

Nonlinear measurements option

For special measurements on nonlinear DUTs, such as the determination of the n dB compression point versus frequency and the SOI and TOI intermodulation products.

Power calibration option

This option is necessary for precise power calibration of the network analyzer. The source power (additional power meter, e.g. NRVD, NRVS or NRV from Rohde & Schwarz required) as well as the absolute power measurement of the receiver input signals can be calibrated.

Virtual Embedding Networks option

This option allows measured networks or simulated networks from a CAD program to be taken into account in the measurement results. Mismatched DUTs such as SAW filters can be matched virtually without any additional hardware being required. Complementary to calibration procedures, the effect of real embedding networks like test fixtures can be eliminated by calculation.

Ethernet option

With this option the analyzer can be networked (LAN).

IEC/IEEE-Bus Interface for Integrated PC option

This option provides a third IEC/IEEE-bus interface to the integrated PC in addition to the two IEC/IEEE-bus interfaces provided as standard.

Generator Step Attenuator PORT 1/2 options

These options permit the power of the output signal at PORT 1/2 to be attenuated in 10 dB steps between 0 dB and 70 dB. The use of an attenuator reduces the dynamic range to >105 dB between 12 GHz and 16 GHz at an IF bandwidth of 10 Hz.

	ZVM	ZVK
Frequency range	10 MHz to 20 GHz	10 MHz to 40 GHz
Attenuation	0 dB to 70 dB	0 dB to 70 dB
Attenuation steps	10 dB	10 dB
Attenuation uncertainty		
up to 30 dB	3 dB	3 dB
above 40 dB	3 dB	3 dB
10 MHz to 20 GHz		5 dB
20 GHz to 33 GHz		
Output power	ZVM	ZVK
up to 16 GHz	-90 dBm to +2 dBm	-90 dBm to -3 dBm
16 GHz to 20 GHz	-90 dBm to -2 dBm	-90 dBm to -9 dBm
above 20 GHz		-90 dBm to -9 dBm
with "Additional Power" setting with reduced specifications		
up to 16 GHz	-85 dBm to +5 dBm	-85 dBm to 0 dBm
16 GHz to 20 GHz	-85 dBm to +2 dBm	-85 dBm to -5 dBm
above 20 GHz		-85 dBm to -5 dBm

Receiver Step Attenuator PORT 1/2 options

These options permit the level of the input signal at PORT 1/2 to be attenuated in 10 dB steps between 0 dB and 70 dB. Moreover, with this option fitted, an additional receiver input – INPUT b1/b2 – is available on the front panel. The use of an attenuator reduces the dynamic range to >105 dB between 12 GHz and 16 GHz at an IF bandwidth of 10 Hz.

	ZVM	ZVK
Frequency range	10 MHz to 20 GHz	10 MHz to 40 GHz
Attenuation	0 dB to 70 dB	0 dB to 70 dB
Attenuation steps	10 dB	10 dB
Attenuation uncertainty		
up to 30 dB	3 dB	3 dB
above 40 dB	3 dB	3 dB
10 MHz to 20 GHz		5 dB
20 GHz to 33 GHz		

Receiver Inputs INPUT b1/b2

Connectors	3.5 mm (male)	2.92 mm (male)
Match above 50 MHz	>10 dB	>8 dB
Maximum nominal input level	-5 dBm	-5 dBm
Damage level	+20 dBm	+20 dBm



Options

Option	Type	Features and benefits
AutoKal	ZVR-B1	Device for automatic full two-port calibration for connection to PORT 1/2. Frequency range DC to 8 GHz. Type N (f) connectors at the DUT side. Connection to ZVM requires PC3.5 (f) to N (f) adapters, for connection to ZVK, 2.92 mm (f) to N (f) adapters are required <ul style="list-style-type: none"> • Full two-port calibration within a few seconds
Time Domain	ZVR-B2	Measurement of step and impulse response, delay measurements, gating in time and frequency domain <ul style="list-style-type: none"> • Localization of discontinuities, determination of reflection coefficients of discontinuities as a function of length/delay, supplementary function for calibration, tuning of filters, optimization of connectors, etc
Mixer Measurements	ZVR-B4	Independent configuration and control of external generators, internal generator and receiver of ZVM and ZVK <ul style="list-style-type: none"> • Easy converter and mixer measurements (conversion gain) • Convenient measurements of amplifier and mixer products vs. frequency (spurious, harmonics, intermodulation products, etc)
Nonlinear Measurements	ZVR-B5	Measurement of n dB compression point and 2nd- or 3rd-order intercept points (SOI/TOI) <ul style="list-style-type: none"> • Display of compression point and SOI/TOI versus frequency
Power Calibration	ZVR-B7	Power calibration to improve absolute amplitude accuracy of generator and receiver <ul style="list-style-type: none"> • High absolute power accuracy of generators (internal and external) and receivers for amplifier and mixer measurements
3-Port Adapter	ZVR-B8	External device extending PORT 1 to 2 ports; frequency range 9 kHz to 4 GHz, type N (f) connectors at the DUT side. Connection to ZVM requires PC3.5 (f) to N (f) adapters, for connection to ZVK, 2.92 mm (f) to N (f) adapters are required <ul style="list-style-type: none"> • Measurements of 3-port devices such as duplex filters
Virtual Embedding Networks	ZVR-K9	Adding virtual or correcting real existing networks by mathematical algorithms <ul style="list-style-type: none"> • Replacing various test fixtures with physical matching networks by one single standard fixture and virtual networks • High accuracy and reproducibility, e.g. in SAW filter measurements
4-Port Adapter	ZVR-B14	External device extending PORT 1 and PORT 2 to 2 ports each (var. 02), or PORT 1 to 3 ports (var. 03); frequency range 9 kHz to 4 GHz, type N (f) connectors at the DUT side. Connection to ZVM requires PC3.5 (f) to N (f) adapters, for connection to ZVK, 2.92 mm (f) to N (f) adapters are required <ul style="list-style-type: none"> • Simultaneous measurement of two 2-port devices • Measurements on diplexers
Ethernet Interface for internal PC	FSE-B16	Ethernet interface for internal PC <ul style="list-style-type: none"> • Control and data transfer of ZVM or ZVK via Ethernet
IEC/IEEE-Bus Interface for internal PC	FSE-B17	IEC/IEEE interface for internal PC (in addition to two IEC/IEEE-bus interfaces provided as standard) <ul style="list-style-type: none"> • Control of ZVM or ZVK and external test equipment by internal PC
Generator Step Attenuator PORT 1	ZVM-B21, ZVK-B21	Mechanical attenuator for generator path to PORT 1. Attenuation between 0 dB and 70 dB in 10 dB steps <ul style="list-style-type: none"> • Decrease of minimum generator output power down to -90 dBm at PORT 1
Generator Step Attenuator PORT 2	ZVM-B22, ZVK-B22	Mechanical attenuator for generator path to PORT 2. Attenuation between 0 dB and 70 dB in 10 dB steps <ul style="list-style-type: none"> • Decrease of minimum generator output power down to -90 dBm at PORT 2
Receiver Step Attenuator PORT 1	ZVM-B23, ZVK-B23	Mechanical attenuator for receiver path from PORT 1 and Input b1. Attenuation between 0 dB and 70 dB in 10 dB steps. Includes additional test port Input b1 <ul style="list-style-type: none"> • Increase of maximum receiver input power at PORT 1 to +27 dBm • Direct access to measurement channel b1
Receiver Step Attenuator PORT 2	ZVM-B24, ZVK-B24	Mechanical attenuator for receiver path from PORT 2 and Input b2. Attenuation between 0 dB and 70 dB in 10 dB steps. Includes additional test port Input b2 <ul style="list-style-type: none"> • Increase of maximum receiver input power at PORT 2 to +27 dBm • Direct access to measurement channel b22

Ordering information

Order designation	Type	Frequency range	Order No.
Analyzers			
Vector Network Analyzer			
4-channel, 50 Ω, active test set	ZVM	10 MHz to 20 GHz	1127.8500.60
Vector Network Analyzer			
4-channel, 50 Ω, active test set	ZVK	10 MHz to 40 GHz	1127.8651.60
Options			
Time Domain	ZVR-B2	–	1044.1009.02
Mixer Measurements ¹⁾	ZVR-B4	–	1044.1215.02
Nonlinear Measurements	ZVR-B5	–	1044.1321.02
Power Calibration ²⁾	ZVR-B7	–	1044.1544.02
Virtual Embedding Networks ³⁾	ZVR-K9	–	1106.8830.02
Ethernet AUI for internal PC	FSE-B16	–	1073.5973.02
Ethernet BNC for internal PC	FSE-B16	–	1073.5973.03
Ethernet RJ45 for internal PC	FSE-B16	–	1073.5973.04
IEC/IEEE-Bus Interface for internal PC	FSE-B17	–	1066.4017.02
Generator Step Attenuator for ZVM, PORT 1	ZVM-B21	–	1128.1009.11
Generator Step Attenuator for ZVM, PORT 2	ZVM-B22	–	1128.1009.21
Receiver Step Attenuator for ZVM, PORT 1 ⁴⁾	ZVM-B23	–	1128.1009.12
Receiver Step Attenuator for ZVM, PORT 2 ⁵⁾	ZVM-B24	–	1128.1009.22
Generator Step Attenuator for ZVK, PORT 1	ZVK-B21	–	1128.1409.11
Generator Step Attenuator for ZVK, PORT 2	ZVK-B22	–	1128.1409.21
Receiver Step Attenuator for ZVK, PORT 1 ⁴⁾	ZVK-B23	–	1128.1409.12
Receiver Step Attenuator for ZVK, PORT 2 ⁵⁾	ZVK-B24	–	1128.1409.22
ZVM, ZVK accessories			
Test Cables (pairs)			
PC3.5 (f)/PC3.5 (m), 50 Ω (for ZVM) ⁶⁾	ZV-Z14	0 GHz to 26.5 GHz	1134.4093.02
2.92 mm (f)/2.92 mm (m), 50 Ω (for ZVK) ⁶⁾	ZV-Z15	0 GHz to 40 GHz	1134.4193.02
Calibration Kits			
PC3.5 (for ZVM)	ZV-Z32	0 GHz to 26.5 GHz	1128.3501.02
PC3.5 incl. Sliding Matches (for ZVM)	ZV-Z33	0 GHz to 26.5 GHz	1128.3518.02
2.92 mm (for ZVK)	ZV-Z34	0 GHz to 40 GHz	1128.3530.02
2.92 mm incl. Sliding Matches (for ZVK)	ZV-Z35	0 GHz to 40 GHz	1128.3547.02
N, 50 Ω	ZV-Z21	0 GHz to 18 GHz	1085.7099.02
TRL Supplementary Kit, N, 50 Ω	ZV-Z26	0.4 GHz to 18 GHz	1085.7318.02
TRL Supplementary Kit, PC3.5, 50 Ω	ZV-Z27	0.4 GHz to 26.5 GHz	1085.7401.02
TOM-X Supplementary Kit, N, 50 Ω	ZV-Z28	0 GHz to 18 GHz	1085.7499.03
TOM-X Supplementary Kit, PC3.5, 50 Ω	ZV-Z29	4 GHz to 26.5 GHz	1085.7647.03

Sliding Matches			
N (m), 50 Ω	ZV-Z41	1.7 GHz to 18 GHz	1085.8095.02
N (f), 50 Ω	ZV-Z41	1.7 GHz to 18 GHz	1085.8095.03
PC3.5 pair m, f (for ZVM)	ZV-Z42	0 GHz to 26.5 GHz	1128.3524.02
2.92 mm pair m, f (for ZVK)	ZV-Z44	0 GHz to 40 GHz	1128.3553.02
General accessories			
Hardware Options N, 50 Ω			
AutoKal ⁷⁾	ZVR-B1	0 GHz to 8 GHz	1044.0625.02
3-Port Adapter ⁷⁾	ZVR-B8	0 GHz to 4 GHz	1086.0000.02
4-Port Adapter (2 x SPDT) ⁷⁾	ZVR-B14	0 GHz to 4 GHz	1106.7510.02
4-Port Adapter (SP3T) ⁷⁾	ZVR-B14	0 GHz to 4 GHz	1106.7510.03
Test Cables (pairs)			
N (m)/N (m), 50 Ω	ZV-Z11	0 GHz to 18 GHz	1085.6505.03
N (m)/N (m), 75 Ω	ZV-Z12	0 GHz to 4 GHz	1085.6570.02
N (m)/PC3.5 (m), 50 Ω	ZV-Z13	0 GHz to 18 GHz	1134.3997.02
Calibration Kits			
N, 50 Ω	ZCAN	0 GHz to 3 GHz	0800.8515.52
N, 75 Ω	ZCAN	0 GHz to 3 GHz	0800.8515.72
Attenuators			
1 W	DNF	0 GHz to 12.4 GHz	0272.4X10.50 ⁸⁾
50 W	RBU 50	0 GHz to 2 GHz	1073.8695.XX ⁹⁾
100 W	RBU 100	0 GHz to 2 GHz	1073.8495.XX ⁹⁾
Matching Pads, N, 50 Ω → N, 75 Ω			
Series Resistor	RAZ	0 GHz to 2.7 GHz	0358.5714.02
L Section	RAM	0 GHz to 2.7 GHz	0358.5414.02
Various Accessories, N, 50 Ω			
T Check	ZV-Z60	0 GHz to 4 GHz	1108.4990.50
Bias Network	ZV-Z61	2 MHz to 4 GHz	1106.8130.02
DC Block	FSE-Z3	5 MHz to 7 GHz	4010.3895.00
Power Splitter 2 x 50 Ω	RVZ	0 GHz to 2.7 GHz	0800.6612.52
External SWR-Bridges			
N (f), 50 Ω	ZRA	40 kHz to 150 MHz	1052.3607.52
N (f), 50 Ω	ZRB2	5 MHz to 3 GHz	0373.9017.52
N (f), 75 Ω	ZRB2	5 MHz to 2 GHz	0802.1018.73
N (f), 50 Ω	ZRC	40 kHz to 4 GHz	1039.9492.52
N (f), 75 Ω	ZRC	40 kHz to 2.5 GHz	1039.9492.72
Miscellaneous			
Transit Case	ZZK-965	–	1013.9437.00
19"-Rack Adapter with front handles	ZZA-96	–	0396.4928.00

¹⁾ Harmonics and arbitrary frequency conversion measurement included.

²⁾ Power meter and sensor required.

³⁾ Only for ZVR, ZVC, ZVM, ZVK.

⁴⁾ Comprises test port 'Input b1', for bypassing coupler at PORT 1.

⁵⁾ Comprises test port 'Input b2', for bypassing coupler at PORT 2.

⁶⁾ For ruggedized port.

⁷⁾ Two adapters PC 3.5 (f)/N (f) or 2.92 mm (f)/N (f) required.

⁸⁾ X = 0: 3 dB, X = 1: 6 dB, X = 2: 10 dB, X = 3: 20 dB, X = 4: 30 dB.

⁹⁾ XX = 03: 3 dB, XX = 06: 6 dB, XX = 10: 10 dB, XX = 20: 20 dB, XX = 30: 30 dB.

General data

Temperature loading	5 °C to 40 °C	EMC, emission	following the provisions of Directives 89/336/EEC, revised by 91/263/EEC, 92/31/EEC, 93/68/EEC and EN50081-1
Specs complied with	0 °C to 50 °C	EMC, immunity	following the provisions of Directives 89/336/EEC, revised by 91/263/EEC, 92/31/EEC, 93/68/EEC and EN50082-1
Operational	-40 °C to +70 °C	Safety	meets EN 61010-1, UL3111-1, CSAC2.2 No. 1010-1, IEC 1010-1
Storage temperature range	meets IEC68-2-1, IEC68-2-2	Power supply	100 V to 120 V (AC) with tolerance ±10%, 6 A, 50 Hz to 400 Hz with tolerance -6% and +10% or 200 V to 240 V (AC) with tolerance ±10%, 3 A, 50 Hz to 60 Hz with tolerance -6% and +10%
Damp heat	40 °C at 95 % rel. humidity, meets IEC68-2-3	Power consumption	safety class I to VDE411
Mechanical resistance		Test mark	280 W (standby: 10 W)
Vibration test, sinusoidal	10 Hz to 55 Hz, max. 2 g, 55 Hz to 150 Hz, 0.5 g constant, 12 min/axis, meets IEC68-2-6, IEC1010-1, MIL-T-28800D class 5	Dimensions (W x H x D)	VDE, GS, CSA, CSA-NRTL/, cE mark
Vibration test, random	10 Hz to 300 Hz, 1.2 g rms, 5 min/axis, meets IEC68-2-36	Weight	435 mm x 281 mm x 584 mm
Shock test	40 g shock spectrum, method 516.3, meets MIL-STD-810D, MIL-T-28800D classes 3 and 5		30 kg
Calibration interval	1 year		



ROHDE & SCHWARZ GmbH & Co. KG · Mühldorfstraße 15 · 81671 München · Germany · P.O.B. 801469 · 81614 München · Germany

Telephone +49894129-0 · www.rohde-schwarz.com · CustomerSupport: Tel. +491805124242, Fax +4989 4129-13777, E-mail: CustomerSupport@rohde-schwarz.com